

TOGETHER WE prepare *oregon*

This booklet will guide you through the steps you and your family need to take to be self-sufficient for the first three days after a major disaster. By taking these steps, you'll be able to respond safely and with confidence in a variety of emergency situations.

SIMPLE STEPS THAT CAN SAVE LIVES

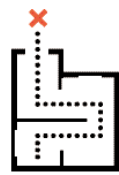

Make a plan

This guide talks extensively about different disasters that could affect the Pacific Northwest. Having a plan in place will make it easier to locate or communicate with your loved ones. The more you have planned ahead of time, the calmer and safer your family will feel in an emergency or disaster (page 3).



Build a kit

Building a three-day emergency supplies kit is an important first step in preparing. This booklet explains what to put in your kit; how to store it; and why it is vital that each family has at least one kit for home, work and car. You can build a kit or buy one from your local Red Cross (page 5).



Get trained

In the event of a disaster, emergency medical response may be delayed for numerous reasons. While precious minutes slip by, your emergency training could mean the difference between life and death. For class descriptions, times and costs, contact your local Red Cross chapter (page 8).



Volunteer

Every day, Red Cross volunteers make a difference in our community. They help provide disaster relief, collect lifesaving blood and assist people in preventing, preparing for and responding to emergencies. Consider giving your time and talent to people in need (page 9).



Give blood

Scheduling regular blood donations ensures that a safe and stable blood supply is available for Oregonians at all times. Blood donated before disaster strikes is critical to immediate needs during relief and recovery efforts. Call 1-800-GIVE LIFE to schedule a blood donation or visit www.nwblood.redcross.org (page 13).

This comprehensive booklet is not only a guide to taking the steps to prepare, but also an explanation of what to prepare for in the Pacific Northwest. The greatest risk here in Oregon could be complacency, as many people are not aware of the potential for natural and human-made disasters in our communities. By taking these simple steps, you can help prepare your family, community, neighborhood, school and workplace.

THE FOLLOWING ORGANIZATIONS CONTRIBUTED CONTENT TO THIS BOOKLET:

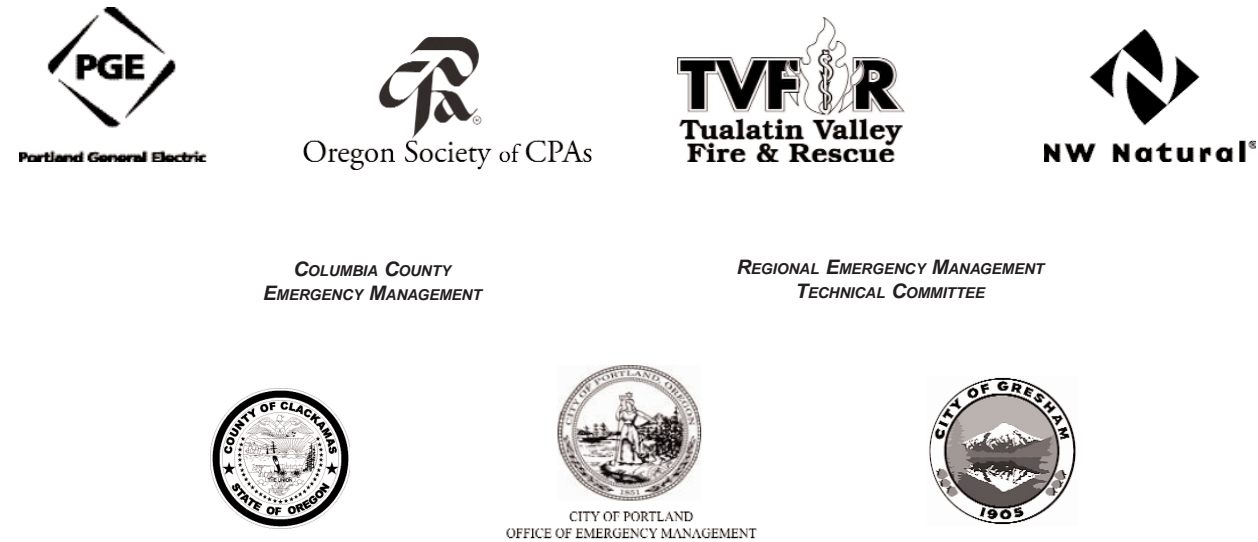

TABLE OF CONTENTS

Make a Plan _____ 3	Utilities _____ 13
Evacuation_____ 3	Water Storage and Food Safety _____ 15
Pets and Disaster_____ 4	Planning for Specific Disasters _____ 17
Your Mental Health_____ 4	Fires at Home_____ 17
Build a Kit _____ 5	Winter Weather and Severe Storms_____ 18
Disaster Supplies Kit Basics_____ 5	Floods_____ 19
First Aid Kits_____ 5	Earthquakes_____ 20
Additional Disaster Supplies_____ 6	Hazardous Materials_____ 22
Get Financially Prepared_____ 6	Wildfires_____ 23
Get Trained _____ 8	Terrorism_____ 24
First Aid and CPR Training_____ 8	Volcanoes_____ 24
Other Lifesaving Classes_____ 8	Tsunamis_____ 25
Basic Lifesaving Tips_____ 8	Pandemic Flu_____ 26
Volunteer _____ 9	Additional Resources _____ 27
Disabilities & Special Needs _____ 10	Emergency Contacts _____ 28
Give Blood _____ 13	

MAKE A PLAN

The more you have planned out ahead of time, the calmer and more assured your family will be during a disaster or emergency.

- Take the time to talk about potential disasters
- Establish emergency contacts
- Practice evacuating your home
- Determine two meeting places where your family will reunite

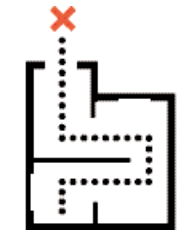

Five Steps to Family Disaster Planning

- 1. Talk** — with your family about disasters that could happen in the Pacific Northwest, such as home fires, wildfires, severe winter weather, flooding, earthquakes, terrorism and hazardous material accidents. All of these disasters are covered in detail in this guide.
- 2. Train** — all family members. Learn to use a fire extinguisher. Locate your utility shut-off valves and know when and how to turn off your gas, electricity and water. Make sure all responsible people in the household have this knowledge or training. Pick two places to meet :
 - (1) right outside of your home in case of a sudden emergency, like a fire.
 - (2) outside of your neighborhood in case you can't return home or are asked to leave your neighborhood. Everyone must know the address and phone number of the meeting locations.
- 3. Take stock** — of supplies you may already have on hand that would be helpful in a disaster. Involve the whole family in collecting and assembling supplies of food, water and emergency tools (see pages 5 and 6).
- 4. Tell** — everyone in the household where emergency contact information will be kept. Post a copy on your refrigerator, keep another with your disaster supplies kit and in your purse, wallet or backpack. Complete the *Emergency Contacts* section on the back of this booklet and make copies for each member of your family. Make sure you have included an out-of-state contact. You may be able to reach them when local phone lines are down.
- 5. Test** — your readiness on a regular basis. Review your family disaster plan and go through supplies at least once a year. Commit to a day or weekend to update phone numbers, hold family fire and earthquake drills and check supplies.

EVACUATION

In certain emergencies, you may need to evacuate your home. Listen to the local radio Emergency Alert System or television and follow the instructions of emergency officials. Evacuate immediately if told to do so. Authorities do not ask people to leave unless they truly feel lives may be in danger. Follow their advice.

Before Evacuating

- ◆ Lock your home. If instructed, turn off water, gas and electricity.
- ◆ Post a message on the door (and put one on your voicemail or answering machine) indicating where you can be found.
- ◆ Wear protective clothing and sturdy shoes and take your disaster supplies kit with you.
- ◆ Use travel routes specified by local authorities.
- ◆ Make arrangements for your pets. **Pets, other than service animals who assist people with disabilities, are not allowed in Red Cross shelters for health and safety reasons.** It is recommended that you pre-identify friends or relatives who agree to take your pets temporarily. Include contact information for these people and your animals' veterinarian in your emergency contact information (see *Pets and Disaster* on page 4).

If you have to evacuate your home for an extended period of time because of a disaster, your local Red Cross will open a shelter at a church, school, recreation center or other public building. Listen for shelter locations announced over the radio Emergency Alert System. Make sure the following items are in your disaster supplies kit, which you will take with you when you evacuate. They will be particularly important if you stay in a shelter or temporary lodging.

- ◆ Prescription drugs in childproof containers
- ◆ Eyeglasses/contact lenses
- ◆ Phone numbers/addresses of people you'll want to contact while in the shelter (see page 7 for a list of important documents you'll need)
- ◆ Pillows
- ◆ Toys and games

PETS AND DISASTER



Be Aware

A disaster will be traumatic for your pets as well as you. Pets, other than service animals who assist people with disabilities, are not allowed in Red Cross shelters for health and safety reasons. Please take the following steps to assure your pets are well-cared for, whether you'll be staying in your home, or you have to evacuate.

Prepare

Assemble a disaster supplies kit for your pet that includes these items:

- ◆ Portable carrier (essential for cats), leashes
- ◆ Food, potable water, bowls and can opener
- ◆ Litter and litter box for cats
- ◆ Medications, pet first aid kit (available from your local Red Cross)
- ◆ Health records, including vaccination records
- ◆ Instructions on feeding schedule and diet for your pet, medications and any special needs
- ◆ Current photos of you with your pets in case they get lost

Take the following steps:

- ◆ Make sure your pet is wearing a securely fastened collar with current ID information.
- ◆ Ask friends or relatives if they would be willing to take your pet temporarily in case of a disaster.
- ◆ Contact motels and hotels outside your local area about their policies on pets staying with you. Keep a list of pet-friendly places. Prepare a list of boarding facilities or veterinarians who could shelter a pet in the event of an emergency. Include 24-hour contact numbers.

YOUR MENTAL HEALTH



Be Aware

Disasters may cause highly emotional responses among family members.

Normal responses include:

- ◆ Numbness, apathy or depression
- ◆ Difficulty concentrating or making decisions
- ◆ Anxiety, restlessness, irritability, fear
- ◆ Disorientation
- ◆ Sleep disturbance
- ◆ Fatigue

Prepare

You can reduce the emotional impact of a disaster by being prepared. Review this booklet with your family. Practice your evacuation plans. Make sure your supplies are in order and emergency contact information is up-to-date. You can't take away the feeling of shock after a disaster, but you can reduce the feeling that everything is out of control.

Respond

After you and your family are out of danger, sit down together and collect yourselves. Limit family decisions to today's needs. Avoid discussions of long-term disaster recovery issues.

Mental Health Survival Tips

- ◆ Stay calm and assured
- ◆ Don't stay by yourself if you can avoid it
- ◆ Accept help from others
- ◆ Notice positives; don't blame
- ◆ Talk about your feelings

For Your Long-Term Adjustment

- ◆ Allow yourself to cry
- ◆ Get some exercise
- ◆ Avoid excessive alcohol/drugs
- ◆ Seek counseling if you continue to feel depressed, anxious or debilitated

BUILD A KIT

What you have on hand when a disaster strikes can make a big difference for your comfort and safety in the hours and days following a disaster. Basic services, such as electricity, gas, water and telephones, may be cut off, or you may have to evacuate at a moment's notice. If you are con-



finied at home, it may take some time for professional emergency responders to get to you, so plan on storing enough supplies for everyone in the family for at least three days. Your family will cope best by preparing for disaster before it strikes.

Disaster Supplies Kit Basics

The following list provides the basic supplies you need to have on hand in case of an emergency (see page 6 for an expanded list). Keep these items in a rugged but easy to carry container such as a large covered trash can, overnight backpack or duffel bag. Keep smaller versions of the kit in the trunk of your car and at work. If you become stranded or are not able to return home, having some items will help you to be more comfortable until help arrives. Store your kit in a structurally sound location.

- Water - one gallon per person per day, for drinking, cooking and sanitary needs
- Food - ready to eat, non-perishable, high-protein, high-calorie foods that you enjoy (peanut butter, canned meats, energy bars, canned fruits and vegetables, etc.)
- First aid kit (see list of items below) and first aid reference guide (available from your local Red Cross)
- Portable battery-operated radio and spare batteries
- Flashlights and spare batteries
- List of emergency contacts (use worksheet on the back page of this booklet to create a list)
- Blankets, extra clothing, sturdy shoes and gloves
- Can opener (non-electric)
- Three-day supply of critical medications, an extra pair of eyeglasses, copies of important documents (see page 6 for a list) and comfort items such as toys, books and games
- Food and water for pets
- A *Together We Prepare Oregon* booklet
- Map of local area in case evacuation to shelters is necessary
- Crescent wrench for utility shut-off
- Duct tape and plastic sheeting or large plastic garbage bags for sheltering-in-place
- Extra cash and coins for emergency purchases and pay phones

(see pages 4 and 6 for items you may need in an evacuation)

First Aid Kits

You can buy a first aid kit or build one using the list below. Check and replenish first aid supplies yearly. Consider enrolling your family in a first aid class. Children over the age of 10 can be enrolled in Red Cross basic first aid training. Call your local Red Cross to buy a kit or register for a class.

- Disposable gloves, 2 pairs
- Scissors and safety pins
- Roller gauze and elastic bandages
- Non-stick sterile pads (different sizes)
- Assorted adhesive bandages
- Triangle bandages, 3
- Aspirin or substitute*
- Antibiotic ointment*
- Current prescription medicines*
- Disinfectant (for cleaning wounds)*
- Petroleum jelly
- Cotton balls
- Sunscreen
- Thermometer
- Tongue depressors, 2
- Soap and clean cloth / moistened towelettes
- Tweezers / needle
- Eye dressing or pad
- Paper tape
- Small plastic cup
- Pen and note paper
- Emergency phone numbers
- American Red Cross first aid reference guide or first aid manual
- Include usual non-prescription medications, including pain relievers, antacids, ipecac, laxatives, hydrocortisone cream and vitamins

*Keep all medications in original containers. Check expiration dates and replace as needed.

Additional Disaster Supplies

Sanitation

- Large plastic trash bags (for trash, waste and water protection)
- Large trash can
- Bar soap and liquid detergent
- Shampoo
- Toothpaste/toothbrushes
- Feminine and infant supplies
- Toilet paper
- Household liquid bleach for water purification, plus eyedropper for measuring (see *Water Storage*, page 16)
- Newspaper to wrap garbage and waste
- Pre-moistened towelettes
- Bucket, plastic trash bags, bleach and two boards to construct a makeshift toilet

Safety and Comfort

- Heavy gloves for cleaning up debris
- Sturdy shoes (keep pair by bed)
- Clothes for protection from cold and rain or extreme heat
- Matches, kept in waterproof, child-resistant container
- Glowsticks or lightsticks
- Garden hose with shut-off nozzle for fighting fire
- Tent and tarps
- Whistle to signal for help

Tools and Supplies

- Crescent wrench, 12 inches or longer (store near natural gas shut-off in waterproof container)
- Axe, shovel, pry bar, broom
- Screwdrivers, pliers, hammer
- Coil of 1/2 inch nylon rope (50 feet)
- Pocket knife and staple gun
- Pen and paper (stored in watertight container)
- Change for telephone or telephone calling card

Emergency Supplies For Your Vehicle & Work

(keep in plastic tub or other container that can be closed)

- Blanket(s) and/or sleeping bag
- Booster cables and tool kit (car only)
- Bottled water (use a heavy plastic bottle specifically made for water storage and fill with tap water)
- Canned fruits/nuts and can opener
- Critical prescriptions
- Emergency flares and distress flag/sign
- First aid kit and reference guide

GET FINANCIALLY PREPARED

The following information provided courtesy of the Oregon Society of CPAs



Financial Preparedness

Another important part of building a kit is to include copies of important documents that can help you be prepared financially for emergency situations. When disaster strikes, having your financial documents in order will help sustain your family during the emergency and streamline the recovery process. You may not be able to do everything suggested below - and that's OK. Do what you can. Taking even limited action now will go a long way toward preparing you financially before a disaster strikes.

Evacuation Box

Buy a lockable, durable box to grab in the event of an emergency. You don't have to wait until you have a special box - even a cardboard box will do to get started. Put important documents in sealed, waterproof plastic bags. Store the box in your home where you can easily get to it. Keep this box with you if you are away from home for an extended period, but don't leave it in an unattended car.

- A small amount of cash in small denominations and/or traveler's checks and a few rolls of quarters
- Copies of driver's licenses and social security cards
- A list of emergency contacts that includes doctors, financial advisors, reputable repair contractors, and family members who live outside your area
- Copies of important prescriptions for medicines and eyeglasses, and copies of children's immunization records
- Copies of health, dental or prescription insurance cards or information
- Copies of your auto, flood, renter's or homeowner's insurance policies (or at least policy numbers), and a list of insurance company telephone numbers

- Negatives for irreplaceable photographs, protected in plastic sleeves
- Backups of computerized financial records
- A list of bank account, loan, credit card and investment account (brokerage and mutual funds) numbers
- Safe deposit box key

- Copies of other important financial and family records or a list of their locations. These would include deeds, titles, wills, a letter of instruction, birth and marriage certificates, passports, relevant employee benefits documents, the first two pages of the previous year's federal and state income tax returns, etc. Originals, other than wills, should be kept in a safe deposit box or at another location.

Emergency Cash

After a disaster, you may need cash for the first few days, or even several weeks. A disaster can shut down local ATMs and banks. Keep a small amount of cash and/or traveler's checks at home in a place where you can quickly get to them, such as in your evacuation box. Money should be in small denominations including a couple rolls of quarters.

Emergency Fund

Set aside money in an emergency fund. This can be difficult to do on a tight budget, but can be well worth the effort. The fund can be very helpful, not only in a disaster, but in other financial crises as well. Keep your emergency funds in a safe, easily accessible account, such as a passbook savings or money market account.

Credit

Try to keep your credit cards paid off. You may have to draw on them to tide you over.

Consider Renting a Safe Deposit Box

Safe deposit boxes are invaluable for protecting originals of important documents. If you don't have a safe deposit box, keep copies in your evacuation box and originals at a separate location, such as with family or friends.

Home safes and fire boxes can be convenient places to store important papers. However, some disasters, such as hurricanes, floods or tornadoes, could destroy your home. It is usually better to store original papers in a safe deposit box or at another location that is not likely to be affected by the same disaster. Keep the key to the safe deposit box in your evacuation box.

Original Documents to Store in a Safe Deposit Box

- Deeds, titles and other ownership records for your home, autos, RVs, boats, etc.
- Birth certificates and naturalization papers
- Marriage license/divorce papers and child custody papers
- Passports and military/veteran papers
- Appraisals of expensive jewelry and heirlooms
- Certificates for stocks, bonds and other investments
- Trust agreements
- Living wills, powers of attorney and health care powers of attorney
- Insurance policies (copies are sufficient)
- Home improvement records
- Household inventory documentation
- Copies of wills

Originals of wills should not be kept in a safe deposit box since the box may be sealed temporarily after death. Keep originals of wills with your local registrar of wills or your attorney.

Professional Advice May be Necessary

Depending on your situation, you may need the advice of a professional financial advisor. There is free financial counseling available when a disaster occurs, or you may want to hire your own professional advisor. When selecting a financial advisor, ask for recommendations from family or friends, or contact the Oregon Society of CPAs at 503-641-7200 / 1-800-255-1470 or www.orcpa.org for professionals in your area. For more financial tips and ideas, please visit the OSCPA Financial Literacy Web site at www.orcpa.org/resources_tools.html.

GET TRAINED

First Aid and CPR Training

Learn the emergency action steps: Check the scene and the victim; Call 9-1-1 or your local emergency number; Care for the victim. Teach children how to dial 9-1-1 in an emergency.



...first aid and CPR and how to use an automated external defibrillator (AED). It could save a life.

Your lifesaving skills will not only be critical during a disaster, but also in an emergency situation, which could happen anywhere and at any time. There are many potentially hazardous situations that could occur where you live and work. Being prepared to respond will help you learn how to keep your family and co-workers safe.

Properly administered first aid or CPR can help stabilize an injured or ailing family member until help arrives. Make sure at least one family member is trained in

Other Safety Courses

In addition to staying current in first aid and CPR training, the Red Cross encourages individuals to get trained in other lifesaving skills:

AED Training
 Babysitter's Training (ages 11-15)
 Basic Aid Training (for ages 10 and up)
 Family Caregiving
 Infant/Child CPR
 Lifeguard Training

Pet First Aid
 Water Safety
 When I'm in Charge (for youth ages 8 to 11 to learn to be safe when at home alone)

Many of these courses are also offered in Spanish. Call your local Red Cross chapter for more information.

Basic Lifesaving Tips

By itself, this text material does not constitute comprehensive Red Cross training or certification.

To receive training and certification in first aid and CPR, call your local Red Cross chapter to register for a class.

If you encounter someone who is injured or ill, apply the emergency action steps: **Check-Call-Care**. Check the scene to make sure it is safe for you to approach. Then check the victim for unconsciousness and life-threatening conditions. Someone who has a life-threatening condition, such as not breathing or severe bleeding, requires immediate care by people trained in first aid and CPR and may require treatment by medical professionals. Call out for bystanders to help, if possible. Call 9-1-1, the workplace emergency number or your local emergency number. If you are unable to get through to 9-1-1, call local fire, police or a local hospital.

In a disaster situation, you may not be able to get through to the emergency medical services system at all. Also, you may not have access to telephones. In these situations, you should shout for help to alert nearby neighbors or others who may be able to help you.



The American Red Cross offers a wide range of classes that can help you be safe and learn how to save lives.

DISEASE PREVENTION

The risk of getting a disease while giving first aid is extremely rare. The following precautions can further reduce the risk:

- ♦ **Avoid direct contact with blood and other body fluids.**
- ♦ **Use protective equipment, such as disposable gloves and breathing barriers.**
- ♦ **Whenever possible, thoroughly wash your hands with soap and water immediately after giving care.**

Here are some steps that you can take to care for someone who is hurt, but whose injuries are not life-threatening.

CONTROL BLEEDING

- ♦ **Cover the wound with a clean dressing and press firmly against the wound (direct pressure).**
- ♦ **Elevate the injured area above the level of the heart if you do not suspect that the victim has a broken bone.**
- ♦ **Cover the dressing with a roller bandage.**
- ♦ **If the bleeding does not stop: (1) Apply additional dressings and bandages. (2) For leg or arm injuries, squeeze a pressure point at the artery against the bone.**
- ♦ **Provide care for shock.**

CARE FOR INJURIES TO MUSCLES, BONES AND JOINTS

- ♦ **Support the injured area.**
- ♦ **Control any external bleeding.**
- ♦ **Apply ice or a cold pack to control swelling and reduce pain.**
- ♦ **Avoid any movement or activity that causes pain.**
- ♦ **If you must move the victim because the scene is becoming unsafe, try to immobilize the injured area to keep it from moving.**

SYMPTOMS OF SHOCK

Shock is a life threatening condition in which not enough blood is being delivered to all parts of the body. Symptoms include:

- ♦ **Restlessness and irritability**
- ♦ **Altered level of consciousness**
- ♦ **Pale or ashen, cool, moist skin**
- ♦ **Blue tinge to lips and nail beds**
- ♦ **Rapid breathing**
- ♦ **Rapid pulse**

CARE FOR SHOCK

- ♦ **Keep the victim from getting chilled or overheated.**
- ♦ **Elevate the legs about 12 inches (if broken bones are not suspected).**
- ♦ **Continue to monitor for airway, breathing and circulation (ABCs).**
- ♦ **Do not give food or drink to the victim.**

CARE FOR BURNS

- ♦ **Stop the burning by cooling the burn with large amounts of water.**
- ♦ **Cover the burn with dry, clean dressings or cloth.**
- ♦ **Treat for shock.**

BE AWARE OF BIOLOGICAL/RADIOLOGICAL EXPOSURE

- ♦ **Listen to local radio and television reports for the most accurate information from responsible governmental and medical authorities about what's happening and what actions you will need to take.**
- ♦ **The Web sites referenced at the end of this booklet can give you more information on how to protect yourself from biological or radiological hazards.**

VOLUNTEER

When a disaster occurs, many volunteers may be needed to provide assistance to affected communities. Being trained before disaster strikes enables relief organizations to situate volunteers in



areas where they are needed. The Red Cross provides training in various functions that will be needed when a large disaster occurs. Some of the courses include:

Introduction to Disaster	Mobile Feeding	Shelter Operations
Loss Verification	Mass Care	Ready Set Roll! Driving an Emergency Response Vehicle
Family Services		

Red Cross disaster volunteers are needed on a continual basis to serve the community. Local Red Cross volunteers respond to a residential fire every 36 hours on average. They provide cash assistance for lodging, meals, clothing and other immediate needs.

In addition to disaster relief, Red Cross volunteers help collect life-saving blood, teach health and safety courses, drive seniors and the disabled to medical appointments and more. Call your local Red Cross to volunteer.

PREPARING FOR DISASTER FOR PEOPLE WITH DISABILITIES AND OTHER SPECIAL NEEDS



For the millions of Americans who have physical, medical, sensory or cognitive disabilities, emergencies such as fires, floods and acts of terrorism present a real challenge. The same challenge also applies to the elderly and other special needs populations. Protecting yourself and your family when disaster strikes requires planning ahead. The following information will help you get started. Discuss these ideas with your family, friends and/or your personal care attendant, or anyone else in your support network and prepare an emergency plan. Post the plan where everyone will see it, keep a copy with you and make sure everyone in your plan has a copy.

CREATE A PERSONAL SUPPORT NETWORK

Organize a personal support network of relatives, co-workers, friends and neighbors who can help you prepare for a disaster and assist you after a disaster happens. They should know your capabilities and needs, and be able to provide help within minutes.

COMPLETE A PERSONAL ASSESSMENT

Decide what you will be able to do for yourself and what assistance you may need before, during and after a disaster. This will be based on the environment after the disaster, your capabilities and your limitations.

- ◆ **Personal Care** – Do you regularly need assistance with personal care, such as bathing and grooming? Do you need adaptive equipment to help you get dressed?
- ◆ **Water Service** – What will you do if water service is cut off for several days or you are unable to heat water?
- ◆ **Personal Care Equipment** – Do you use a shower chair, tub transfer bench or similar equipment?
- ◆ **Adaptive Feeding Devices** – Do you use special utensils that help you prepare or eat food independently?
- ◆ **Electricity-Dependent Equipment** – How will you continue to use equipment that runs on electricity, such as dialysis, electrical lifts, etc.? Do you have a safe back-up power supply and how long will it last?

- ◆ **Disaster Debris** – How will you cope with the debris in your home or along your planned exit route following the disaster?
- ◆ **Transportation** – Do you need a specially-equipped vehicle or accessible transportation?
- ◆ **Errands** – Do you need to get groceries, medications and medical supplies? What if your caregiver cannot reach you because roads are blocked or the disaster has affected him or her as well?
- ◆ **Building Evacuation** – Do you need help to leave your home or office? Can you reach and activate an alarm? Will you be able to evacuate independently without relying on auditory cues (such as noise from a machine near the stairs – these cues may be absent if the electricity is off or alarms are sounding)?
- ◆ **Building Exits** – Are there other exits (stairs, windows or ramps) if the elevator is not working or cannot be used? Can you read emergency signs in print or Braille? Do emergency alarms have audible and visible features (marking escape routes and exits) that will work even if electrical service is disrupted?
- ◆ **Getting Help** – How will you call or summon the help you will need to leave the building? Do you know the locations of text telephones and phones that have amplification? Will your hearing aids work if they get wet from emergency sprinklers? Have you determined how to communicate with emergency personnel if you don't have an interpreter, your hearing aids aren't working or you don't have a word board or other augmentative communication device?
- ◆ **Mobility Aids / Ramp Access** – What will you do if you cannot find your mobility aids? What will you do if your ramps are shaken loose or become separated from the building?
- ◆ **Service Animals/Pets** – Will you be able to care for your animal (provide food, shelter, veterinary attention, etc.) during and after a disaster? Do you have another caregiver for your animal if you are unable to meet its needs? Do you have the appropriate licenses for your service animal so you will be permitted to keep it with you should you need or choose to use an emergency public shelter?



Action Checklist – Items To Do Before a Disaster

CONSIDERATIONS FOR PEOPLE WITH DISABILITIES

Those with disabilities or other special needs often have unique needs that require more detailed planning in the event of a disaster. Consider the following actions as you prepare:

- ◆ Learn what to do in case of power outages and personal injuries. Know how to connect and start a back-up power supply for essential medical equipment.
- ◆ Consider getting a medical alert system that will allow you to call for help if you are immobilized in an emergency. Most alert systems require a working phone line, so have a back-up plan, such as a cell phone or pager, if the regular landlines are disrupted.
- ◆ If you use an electric wheelchair or scooter, have a manual wheelchair for back-up. Teach those who may need to assist you in an emergency how to operate necessary equipment. Also, label equipment and attach laminated instructions for equipment use.
- ◆ Store back-up equipment (mobility, medical, etc.) at your neighbor's home, school or your workplace.
- ◆ Arrange for more than one person from your personal support network to check on you in an emergency, so there is at least one back-up if the primary person cannot.
- ◆ If you are vision impaired, deaf or hard of hearing, plan ahead for someone to convey essential emergency information to you if you are unable to use the TV or radio.
- ◆ If you use a personal care attendant obtained from an agency, check to see if the agency has special provisions for emergencies (e.g., providing services at another location should an evacuation be ordered).
- ◆ If you live in an apartment, ask the management to identify and mark accessible exits and access to all areas designated for emergency shelter or safe rooms. Ask about plans for alerting and evacuating those with sensory disabilities.
- ◆ Have a cell phone with an extra battery. If you are unable to get out of a building, you can let someone know where you are and guide them to you. Keep the numbers you may need to call with you if the 9-1-1 emergency number is overloaded. A whistle is another good way of alerting people that you need assistance if phones are not working.
- ◆ Learn about devices and other technology available (PDAs, text radio, pagers, etc.) to assist you in receiving emergency instructions and warnings from local officials.

GIVE BLOOD

The American Red Cross Pacific Northwest Regional Blood Services must collect at least 5,000 pints of blood each week to meet the needs of local patients. The organization is the sole supplier of blood and blood products to more than 80 hospitals in Oregon, Washington and southeast Alaska. To schedule a blood donation, call 1-800 GIVE LIFE. In the Portland metro area, call (503) 284-4040.



In addition to whole blood, the Red Cross collects platelets for patients undergoing special treatment. Platelets are one component of blood that aid in the clotting process.

Platelets prevent or stop bleeding and help treat patients with cancer, leukemia and other diseases. Since platelets can be stored for only five days, there is a constant need.

To schedule a platelet donation at the Portland Donor Center, please call (503) 280-1446.



Eligible donors can give every 56 days. Blood is a cornerstone of medicine and critical to public health, but whole blood has a limited shelf life. The need for blood is constant.

Through the power of the Red Cross national system, blood can quickly be shipped from one area of the country to another - wherever it is needed most.

The American Red Cross encourages eligible donors to give blood regularly.

Visit www.nwblood.redcross.org for more information.

UTILITIES



Natural Gas

The following information provided courtesy of NW Natural



Your gas company injects an odorant into your gas before it is distributed. The odorant is so highly concentrated that even the smallest amounts of natural gas can be detected. The odorant gives off a foul smell like rotten eggs.

Any odor of natural gas inside your home may indicate a leak. Follow these steps if you detect a leak:

- ◆ **Open windows and doors.**
- ◆ **Evacuate all persons from the building.**
- ◆ **Call NW Natural at (800) 882-3377 or your local gas company from a neighbor's phone or a phone far away from the building.**
- ◆ **Don't use the telephone in the building with the odor (including cell phones and other portable communication devices with a battery). These can spark and create an ignition source.**
- ◆ **Don't light matches or create any other source of ignition.**
- ◆ **Don't turn lights off or on, or operate any electrical switches (either off or on). This could create a source of ignition.**

If there is a strong gas odor in your home, or you can see or hear a break, follow the instructions above.

UTILITIES

Meanwhile, turn off the gas valve located at the gas meter (see instructions and illustration below) with a wrench or other suitable tool. If the leaking gas ignites, do not attempt to put out the flames. Get to safety, call 9-1-1, and then call your local gas company.

NOTE: Turn off the gas valve only if you smell a strong gas odor or hear gas leaking.

Shutting Off Your Gas

If you need to have your gas shut off, call your gas company to do it, if possible. However, in an emergency, when you need the gas shut off immediately, take these steps:

- ◆ Locate the shut-off valve on the riser pipe (the pipe running out of the ground to your meter). To turn the valve, you will need a crescent wrench, pipe wrench or a special wrench available from NW Natural or your local gas company.
- ◆ When the valve head is parallel to the riser pipe, it is in the "on" position. Turn the valve head crosswise to the pipe and it will be in the "off" position (see illustration above). There are also shut-off valves on the lines feeding individual gas appliances.
- ◆ Once the gas is off, leave it off. Call the nearest gas company office when you are ready for the gas to be turned back on. A qualified technician will check your system, turn on your service and re-light the pilot for you.

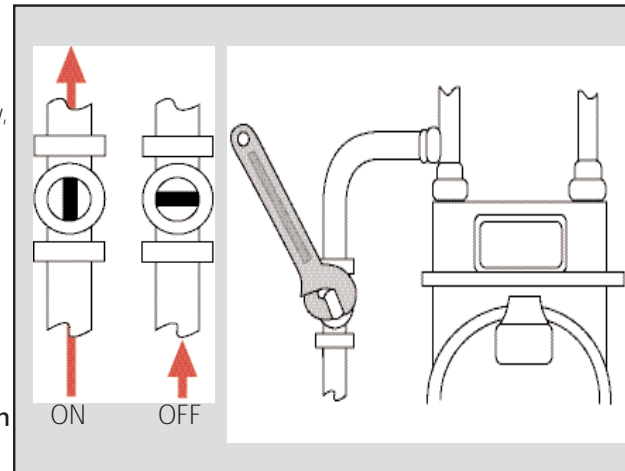

Water

Earthquakes or severe freezing weather can interrupt water supplies. It's important to turn off the water quickly to avoid flooding or possible contamination of your water system. Locate the main water valve, often near the wall in a basement or garage. Label it for quick identification. If you need to turn the water off, turn the valve clockwise until it stops.

Electricity

The following information provided courtesy of Portland General Electric



IF THE POWER GOES OUT:

1. Check your fuse or breaker box for blown fuses or tripped circuits. If they're okay, check to see if your neighbors are without power.
2. Call your power company immediately (record utility outage contact numbers on back page) to report the outage. Please call only once so other customers can get through.
3. Turn off all electrical equipment including your water heater, electric furnace or heaters, stove, washer and dryer, stereo and TV to help prevent overloading the system when power is restored (major appliances can be turned off at the breaker box). Do, however, turn on a porch light and one inside light so you and repair crews will know when service is restored.
4. Listen to the radio (battery-powered) for updates on major storm outages. You can also call your power company for information on when power will be restored.
5. If your neighbor's power comes back on but yours does not, call your power company again.
6. If your lights are very dim or very bright once power is restored, turn off the power at the breaker or fuse box and call your power company.

UTILITIES

Downed Power Line Safety

Never touch a downed power line – electricity can travel through your body causing serious injury or death. If you see any line on the ground, assume that it might be live and stay away. Take the following precautions:

- ◆ Expect every line to be live. If you see a downed line, call the local power company immediately.
- ◆ If a line is touching someone, stay away; you could become a victim if you touch the person. Call 9-1-1 for emergency medical help.
- ◆ If a line falls across your vehicle, do not get out! Wait for emergency help to arrive. If you have to get out of your car, (example: it's on fire) don't touch the car and the ground at the same time. This would give the electricity a path to the ground.
- ◆ Keep on the lookout for crews repairing downed lines. Slow down when approaching work areas and always obey flaggers.

Special Instructions For Life Support Patients

If someone in your home is on life support, it is critical that you have a back-up generator. If the power goes out, the utility company will not be able to help and power will have to be found from another source.

Generator Safety

Owners of portable or auxiliary generators should note these precautions.

- ◆ Never plug your generator into a wall outlet. It can result in injury to you or others and damage to your electrical system.
- ◆ Portable generators are gasoline-powered and should always be placed in a well-ventilated area. Use an indoor/outdoor, grounded (three-prong) extension cord to connect your generator to an appliance.
- ◆ Permanently installed auxiliary generators must meet electrical codes and have a transfer switch to prevent dangerous back-feed of electricity into power lines. Contact a licensed electrician. Also, please notify your power company if you have a permanent generator.

WATER STORAGE AND FOOD SAFETY

You will need more water than you might think in an emergency. Store a minimum of three days worth of water per person: one gallon per person per day (and the same amount for each pet). **IF YOU ARE RUNNING LOW ON WATER IN AN EMERGENCY, DO NOT RATION. DRINK WHAT YOU NEED TODAY, TRY TO FIND MORE FOR TOMORROW. FILL UP THE TUB IF YOU HAVE TIME, BUT DO NOT USE FOR DRINKING.**



FOLLOW THESE STEPS TO ACCESS THE WATER IN YOUR HOT WATER TANK:

1. Find your incoming water valve. Shut it off to avoid possibly contaminated water coming into the tank.
2. Turn off the gas or electricity to the tank.
3. Turn on a hot water faucet in the house.
4. Collect water as needed from the tap at the bottom of the hot water heater.

Other Indoor Water Sources

- ◆ Toilet tank (not the bowl). Do not use if you have added chemical treatments to the tank
- ◆ Ice cubes — melt and use
- ◆ Liquids from canned goods such as fruit and vegetable juices

UNSAFE WATER SOURCES: radiators, waterbeds and swimming pools

Proper Water Storage

- ◆ Store bottled drinking water out of direct sunlight, away from chemicals which might permeate the container and in an area not likely to freeze.
- ◆ If bottling tap water, buy empty containers or use well-washed plastic soda bottles (do not use empty bleach, detergent or milk containers!). Every six months, empty tap water from containers, wash containers and refill.
- ◆ Pouring water back and forth between two containers will add oxygen and make the water taste better.

Treating Water

If you are uncertain about the purity of any water source, treat it before you use it for drinking, food preparation or hygiene. In addition to having a bad odor and taste, water from questionable sources may be contaminated by a variety of microorganisms that can cause dysentery, cholera, typhoid and hepatitis.

TO TREAT WATER, FOLLOW THESE STEPS:

1. Filter the water using a piece of cloth or coffee filter to remove solid particles.
2. Bring it to a rolling boil for about one full minute.
3. Let it cool at least 30 minutes. Water must be cool or the chlorine treatment described below will not work.
4. Add 16 drops of liquid chlorine bleach per gallon of water, or 8 drops per 2-liter bottle of water. Stir to mix. Sodium hypochlorite (concentration 5.25% to 6%) should be the only active ingredient in the bleach. There should be no added soap or fragrance.
5. Let stand 30 minutes.
6. If the water smells of chlorine, you can use it. If it does not smell of chlorine, repeat steps 4 and 5 above. If after this second try the water smells of chlorine, you can use it. Otherwise, discard and find another source of water.

People with certain medical conditions may need distilled or sterile water. Your physician can tell you whether you fall in this category. If so, the Red Cross can provide you with instructions on how to distill water.

Food Safety In An Outage

While the power is out, your food supplies can be saved by following these simple steps:

If your freezer is full, food will stay frozen for about two days. If it is less than half full, food will stay frozen for about one day. Cover the freezer with blankets, quilts or sleeping bags to further insulate the freezer and help food stay frozen longer. After power is restored, check all frozen foods to determine the extent of thawing. Dispose of any food that is discolored or smells spoiled. If in doubt, throw it out.

To avoid losing the cold air in your refrigerator, don't unnecessarily open its doors. Meat and fish spoil quickly at temperatures above 40°F. Other quick-spoiling foods include milk, custard, creamed foods and any foods containing mayonnaise or eggs. Cooked and cured meat will keep for several days in a closed refrigerator. Hard cheeses keep well, even at room temperature. Again, if in doubt, throw it out. You might also try placing bags of ice in the refrigerator, or place food in a cooler or ice chest with ice.

Cooking During An Outage

Never use barbecues or liquid fuel stoves to cook/heat food indoors. Cooking with these types of appliances will produce carbon monoxide. Carbon monoxide is odorless, colorless and deadly.

PLANNING FOR SPECIFIC DISASTERS

FIRES AT HOME

Be Aware

Fire is the fifth leading cause of unintentional injury and death in the United States. It also ranks as the first cause of death in the home for children under the age of 15.



Prepare

- ◆ Install working smoke alarms that have long-life lithium batteries and a hush button on each level of your home (on the ceiling, inside each bedroom, in the basement, near but not in the kitchen).
- ◆ Check smoke alarms once a month by pressing the test button. If alarm doesn't sound, replace battery immediately. Change batteries yearly unless using lithium batteries. Replace smoke alarms after ten years of use.
- ◆ Make an escape plan. Identify two exits from every room in your home.
- ◆ Agree on a reunion site immediately outside of the house where family members will meet.
- ◆ Remind everyone to exit quickly and call 9-1-1 from a safe location away from the home.
- ◆ Practice crawling out of the home with your eyes shut. Heavy smoke and poisonous gases make it hard to see and breathe. Staying low increases your chance of escape.

FIRE EXTINGUISHER: Purchase an A-B-C type fire extinguisher and teach all responsible family members how to use it. Fire extinguishers are for small fires only. When using one, stand back ten feet from the fire, keep your back to an exit and remember the **PASS** sequence:

- ◆ Pull the pin out.
- ◆ Aim the extinguisher at the base of fire.
- ◆ Squeeze or press the handle.
- ◆ Sweep from side to side at the base of the fire.

Whether you are a renter or a homeowner, buy fire insurance!

Respond

ESCAPE: If you are in a building and smell smoke or see fire, get out quickly and call 9-1-1 from a safe place:

- ◆ Sleep with bedroom doors closed. If the smoke alarm sounds, crawl to the door; the freshest air will be closer to the floor.
- ◆ Before opening a door in a burning building, kneel down and check the air coming under the door and also feel the door handle and door with the back of your hand. If the air, handle and door are cool and you don't smell smoke, kneel behind the door while you open it just a little with your face turned away from the opening. Listen and smell for fire and smoke. If smoke is present, use another exit.
- ◆ Close doors behind you as you leave.
- ◆ Use a stairway, NOT AN ELEVATOR, to escape from a burning building.



STAY LOW AND GO

IF YOU'RE TRAPPED BY FIRE AND HEAVY SMOKE:

- ◆ Stay low under the smoke and close the doors between you and the fire (see illustration at right).
- ◆ Open a window slightly and hang something out of it (like a shirt or towel) to attract attention. Stay low and leave the window slightly open for ventilation.
- ◆ If your clothes catch on fire, stop where you are, cover your face, drop to the ground and roll back and forth. **STOP, DROP AND ROLL!**

Your local fire department can answer further questions about smoke alarms, fire extinguishers or fire safety.

WINTER WEATHER AND SEVERE STORMS



Be Aware

Heavy snowfall, ice storms or extreme cold can immobilize our entire region. Even with our mild Northwest winters, we can have paralyzing cold. Results can range from isolation to major traffic hazards on icy highways.

Prepare

Understanding weather warnings on the radio or TV:

TRAVELERS ADVISORY is issued when ice and snow are expected to hinder travel.

WINTER STORM WATCH means severe weather conditions – such as freezing rain, sleet or heavy snow – could affect your area. Avoid unnecessary travel before or during the storm.

WINTER STORM WARNING means severe weather is occurring or about to occur. Stay indoors during the storm and avoid travel.

You should be ready for winter weather by November 1

- ◆ Check home and car disaster supplies kits (see pages 5 and 6).
- ◆ Review family back-up plans for cooking, heating and lighting. Choose safe alternate sources (flashlights or electrically-powered lanterns, NOT candles or gas lanterns!).
- ◆ If you have a fireplace or wood stove, stock up on seasoned wood and have your chimney or stovepipe checked and cleaned by a professional.
- ◆ Insulate water pipes with fiberglass or foam insulation.
- ◆ Winterize your cars — check and adjust or replace antifreeze before November 1.
- ◆ Keep your car's gas tank full for emergency use and to keep the fuel line from freezing.

Respond

Outages can occur at any time of the year, but during cold weather the temperature inside your home can drop rapidly. Take these simple precautions to safely stay warm if you do lose power.

SAVE BODY HEAT - Wear a hat, even while sleeping. Wear loose layers of clothing to trap body heat. Keep moving; exercise generates body heat. Use plenty of blankets and a hot-water bottle if you're able to heat water.

BE ALERT - Watch for signs of hypothermia (a drop in core body temperature) especially in infants and the elderly. Even air temperatures of 65°F can trigger hypothermia, and some medical conditions can make people more susceptible. If someone has a body temperature below 95°, call for medical help. Check on elderly neighbors, too.

SIGNS OF HYPOTHERMIA:

Be aware of shivering, slow and irregular pulse, numbness, glassy stare, apathy or impaired judgement, loss of muscle control, no shivering or loss of consciousness (late stages).

LOCK IN HOME HEAT - Pick one room on the sunny side of the house and close it off to keep the heat in. Use blankets to insulate windows and doors.

USE HEAT SOURCES SAFELY - Keep fire-fighting materials handy: baking soda and a fire extinguisher. Local laws prohibit the use of kerosene heaters indoors.

HAVE A BACK-UP PLAN - If your neighborhood experiences an extended outage, can you stay with friends or relatives in another area of town?

Before and During a Severe Storm:

The Northwest has experienced several devastating windstorms in the past four decades. If high winds are forecast for your area, you should:

- ◆ Identify a shelter or safe place within your home, away from windows, that will provide you with maximum protection.
- ◆ Identify items that must be secured or brought inside during high winds (such as toys, lawn furniture or tarps). Bring these objects inside or anchor them.
- ◆ Know what to do if the power goes out (see page 14).
- ◆ Stay indoors and away from windows.
- ◆ Do not drive.
- ◆ Stay tuned to a local TV or radio station for weather and emergency information.

FLOODS

Be Aware

Floods claim dozens of lives in the United States every year. Flood waters only half a foot deep can be strong enough to sweep you off your feet.



Prepare

- ◆ Check with your local emergency manager to find out if your home is on a flood plain. Even if it is not, you should be prepared for a flood.
- ◆ If you do live on a flood plain, assemble materials such as plywood, plastic sheeting and sandbags that you may need in a flood.
- ◆ Discuss flood insurance coverage with your agent. Normal homeowners insurance does not cover flooding and there is a 30-day waiting period.
- ◆ Plan your evacuation (see *Evacuation* on page 3).
- ◆ Make sure you have disaster supply kits at home, your workplace and your car.

For more information about the National Flood Insurance Program managed by FEMA, contact your local emergency management office.

Understand flood forecasts, warnings and watches broadcast on local TV and radio. Consider purchasing an NOAA weather radio.

FLOOD FORECAST means rainfall is heavy enough that rivers will overflow their banks.

ACTION: Discuss a possible evacuation.

FLOOD WATCH means flooding is possible in your area.

ACTION: Fill your car's gas tank in case an evacuation notice is issued.

FLOOD WARNING means flooding is occurring or will occur very soon.

ACTION: If instructed by local authorities, turn off utilities if your home is likely to be flooded.

FLASH FLOOD WATCH means heavy rains are occurring or expected and are likely to cause flash flooding in specific areas.

ACTION: Prepare for evacuation if you are in the watch area.

FLASH FLOOD WARNING means flash flooding is occurring or imminent in designated areas.

ACTION: If your area is affected, evacuate immediately to higher ground. If you are driving, stay away from storm drains and irrigation ditches. Never drive around a police barricade. If your car stalls in rapidly-rising water, abandon it immediately and climb to higher ground.

Respond

DURING HEAVY RAINS

- ◆ Listen carefully to the radio Emergency Alert System for specific instructions from emergency officials, such as filling your bathtub with water for flushing the toilet, washing the floor or clothing, securing your house, putting out sandbags or evacuating to higher ground.
- ◆ If told to evacuate, follow all evacuation instructions carefully (see page 3).
- ◆ Keep in mind that 6" of water will reach the bottom of most cars, causing loss of control and possible stalling. It's hard to tell how deep water is or how stable the ground is beneath.

EVACUATING TO HIGHER GROUND

- ◆ If you see any possibility of a flash flood occurring, move immediately to higher ground. Do not wait for instructions to move.
- ◆ Walking or driving through flood waters is the most dangerous thing you can do.

AFTER THE FLOOD

- ◆ Contact your local emergency management office and insurance company for guidance on safely returning to a flood-damaged home.
- ◆ Avoid contact with flood waters and throw away food, cosmetics or medications that have touched flood waters.

EARTHQUAKES



Be Aware

The threat of earthquakes in the Pacific Northwest is real. Scientists predict a magnitude 8.0 or greater earthquake could occur at any time.

Prepare

- ◆ Pick “safe spots” in each room of your home. A safe spot could be under a sturdy table or desk or against an interior wall away from windows, bookcases or tall furniture that could fall on you.
- ◆ Practice **DROP, COVER AND HOLD ON** in each safe spot. Drop under a sturdy desk or table, hold on and protect your eyes by pressing your face against your arm.
- ◆ Discuss the possibility of an earthquake with your family, and go through the disaster supplies checklists (see pages 5 and 6) to make sure you have everything you need to be self-sufficient for three days.
- ◆ Does anyone need training, such as first aid or instruction in turning utilities off? Make a list of who needs to learn what and set aside a time for training. At least one household member should be certified in first aid and CPR.
- ◆ Review and update your family plan yearly or as needed. Are phone numbers current? Are safety spots still practical? Has the plan for reuniting the family changed?
- ◆ Conduct a home hazard hunt. Bolt bookcases and china cabinets to wall studs and place heavier objects on lower shelves. Install strong latches on cupboards. Secure wall hangings with special hooks (don’t hang anything over the bed).

Respond

- ◆ When the ground begins to shake, **DROP, COVER AND HOLD ON!**

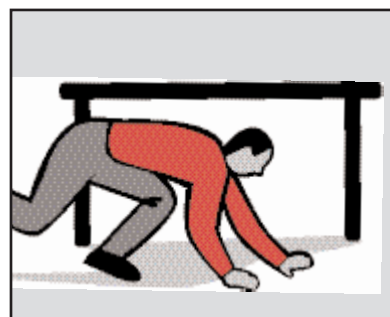

DROP

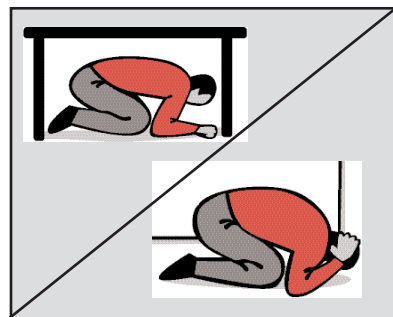

COVER

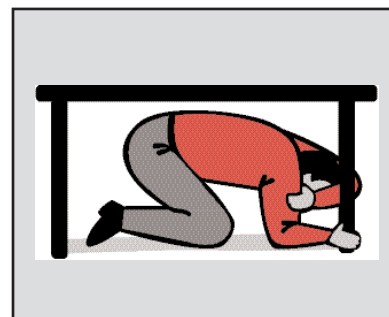

HOLD ON

- ◆ If inside during an earthquake, stay there. Move only a few steps to a nearby safe spot (10 feet or less). If you are in bed, hold on and stay there, protecting your head with a pillow.
- ◆ If outdoors during an earthquake, stay there. Find a clear spot away from buildings, trees, street lights and power lines. Drop to the ground until the shaking stops. If you are in a vehicle, pull over to a clear location, stop and stay there with your seatbelt fastened until the shaking has stopped. Once the shaking has stopped, proceed with caution.
- ◆ When the shaking has stopped, check for injuries and provide first aid.
- ◆ Protect yourself from further danger by putting on shoes and work gloves. This will protect you from further injury by broken objects.
- ◆ Look for and extinguish small fires. Eliminate fire hazards.
- ◆ Leave the gas on at the main valve unless you smell gas or think it is leaking. Turn off water if necessary (see pages 14 and 15). Assume any downed power lines are live and **STAY AWAY** (see page 15).
- ◆ Immediately clean up dangerous spills such as medicine, bleach, gasoline or other flammable liquids.
- ◆ Turn on a portable radio and listen for instructions from public safety agencies.
- ◆ Use phones **ONLY** for emergencies. Unnecessary calls can prevent others from getting emergency help.
- ◆ Watch animals closely. Leash dogs and place them in a fenced yard. The behavior of pets may change dramatically after an earthquake.
- ◆ Don’t turn on any electricity after a major earthquake.

Strapping Your Water Heater

A water heater that is not strapped to the frame of your home can tip over in an earthquake, potentially causing a gas explosion hazard and wasting a possible source of water if city water supplies are interrupted. You can get advice and materials for strapping your water heater at most hardware/home improvement stores.

There are many methods for strapping water heaters. The method described below is recommended for fire safety so no flammable materials are in direct contact with the water heater.

Before You Start

First ensure that your water heater is fitted with a flexible gas supply line. If your water heater does not have a flexible gas supply line, contact a licensed plumber to install one.

MATERIALS NEEDED

- ◆ (2) Six-foot lengths of 1-1/2-inch, 16-gauge pre-drilled strap
- ◆ (1) 10-foot length of 1/2-inch EMT tube (conduit)
- ◆ (4) 5/16-inch lag screws with washers
- ◆ (4) 5/16-inch x 3/4-inch long hex head machine bolts with four nuts and eight washers each
- ◆ (2) 5/16-inch x 1-1/4-inch long hex head machine bolts with one nut and two washers each

TOOLS NEEDED

- ◆ Tape measure
- ◆ Power drill
- ◆ Hammer
- ◆ Hacksaw
- ◆ Crescent wrench
- ◆ Vise or clamp
- ◆ 3/8-inch drill bit
- ◆ 3/16-inch drill bit
- ◆ Center punch

Strapping Instructions

The following instructions are for strapping a 30-40 gallon water heater located within 12 inches of a wall stud.

1. Measure 6 inches down from top of the water heater and about 18 inches up from bottom. Do this on both sides of the water heater. Make marks on both sides of the water heater.
2. Mark the location of the studs in the wall (you may want to use a stud locator) at the same height as the four marks you made on the water heater.
3. Drill four holes, using a 3/16-inch drill bit, three-inches deep into the center of the wood studs.
4. Measure the distance around the water heater and add two inches to the measurement. Using a hacksaw, cut the two 1-1/2-inch x 16 gauge metal straps to the measurement.
5. Mark 1-1/2 inches from each end of the two metal straps. Insert each end in a vise (or under a heavy object) and bend the 1-1/2-inch ends outward into a right angle.
6. Bend the two straps into a curve to surround the water heater.

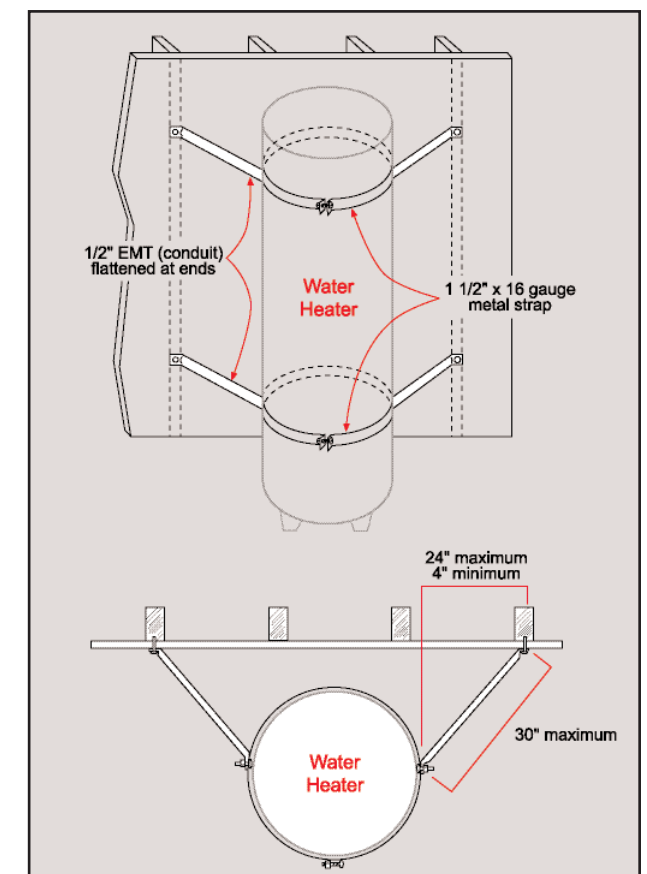

7. Measure the distance from a point halfway on each side of the water heater to the two upper holes drilled in the wall (these may be different lengths.) Add 1-1/2 inches to each measurement. Use a hack saw to cut two pieces of conduit to each of these two lengths.
8. Take the two pieces of tubing and flatten approximately 1-1/2 inches at each end. Simply lay the tube on a flat metal or concrete surface and flatten the ends with a hammer.
9. With a hammer and the center punch, make a mark 3/4" from each of the flattened tubing ends. Drill a 3/8" hole through the marks. Be sure the tube is clamped down while drilling. Use the vise or clamp to bend the EMT conduit to allow the flattened ends to fit flush against the wall and water heater (about 45°F).
10. Wrap the straps around the heater and insert a 5/16-inch x 1 1/4-inch bolt with washers into the bent ends. Tighten nuts with fingers.
11. Insert 5/16-inch x 3/4-inch bolts through strap from the inside at the mid-point on each side of water heater. Attach one end of each flattened tube to a protruding bolt. Add a washer and nut and tighten with fingers.
12. Insert a 5/16-inch lag screw in the opposite end of each tube strut and screw it into the wall stud. You may need to tap the lag screw gently into the hole with a hammer to start it, then tighten the screws with a crescent wrench.
13. Adjust straps to proper height and tighten nuts snugly, but not too tight.

HAZARDOUS MATERIALS



Be Aware

Hazardous materials come in the form of explosives, flammable and combustible substances, poisons and radioactive materials. These substances are most often released as a result of transportation accidents or because of chemical accidents in manufacturing plants.

Prepare

- ◆ Discuss the potential for a hazardous material accident in your community. The risk is split between trucks and trains passing through your area and material stored in the area. Your local emergency management office can help you identify sites in your area where hazardous materials are stored or processed, what kind of materials they are and what risk they carry.
- ◆ Review your family's evacuation plan. Make sure you understand the specialized procedures for responding to a hazardous materials accident.

Respond

- ◆ If you witness or become aware of a hazardous materials accident, immediately call 9-1-1.
 - ◆ Turn on your television or radio and exactly follow directions. Hazardous materials incidents often involve substances that you cannot see or smell. You may be exposed to a toxic chemical through breathing, touching, eating or drinking without being immediately aware of the exposure.
 - ◆ Stay away from the incident site to avoid getting contaminated. If you are asked to evacuate, do so immediately.
 - ◆ You may be instructed to stay indoors rather than evacuate. This is called sheltering-in-place. If told to shelter-in-place, immediately get inside your home or office and close and lock all windows and exterior doors.
 - ◆ Turn off all fans, heating and air conditioning systems. Close the fireplace damper.
 - ◆ Get your family disaster supplies kit and make sure the radio is working.
 - ◆ Go to an interior room with the fewest windows that's above ground level. In the case of a chemical threat, an above-ground location is preferable because some chemicals are heavier than air, and may seep into basements.
 - ◆ Bring your pets with you, and be sure to bring additional food and water supplies for them.
 - ◆ Use duct tape and plastic sheeting (heavier than food wrap) to seal all cracks around the door and any vents into the room.
 - ◆ Keep listening to your radio or television until you are told all is safe or you are told to evacuate.
 - ◆ Remember that instructions to shelter-in-place are usually provided for durations of a few hours, not days or weeks.
- There is little danger that the room in which you are taking shelter will run out of oxygen.

WILDFIRES

Be Aware

If your home is near a forest, prairie, valley or hillside, you need to be prepared for wildfire.



Prepare

You should safeguard your home by taking the following precautions:

- ◆ Roofing should be made of noncombustible material, such as composition shingles, tile, slate, cement shingle, sheet metal or aluminum.
- ◆ Trees need to be trimmed away from your roof. Limbs should reach no closer than 10 feet from the house.
- ◆ Plant low, less flammable plants near the house; higher, more flammable plants at a distance (contact your local Forestry Department for specific plant recommendations and distance guidelines).
- ◆ Flammables should be stored away from the home. Stack firewood at least 100 feet away and uphill from your home.
- ◆ Yard should be well-trimmed and free of debris – keep trees and bushes well-trimmed and free of dead branches. Remove woody debris on a regular basis.
- ◆ You should have a 30-foot noncombustible fire break around the home. If you live in a forested area within a city, you may need a permit to cut vegetation because of environmental zones.
- ◆ If your home is on a slope, you should leave a 100-foot buffer zone (see illustration above), since wildfire travels fastest uphill.
- ◆ Make sure you have an adequate water supply to fight a fire (i.e., cistern, hydrant, or swimming pool with a high-volume pump). Keep a hose with a nozzle connected to an exterior water source at all times.
- ◆ Make sure to provide good access for emergency vehicles. Your driveway should be 12 feet wide with a vertical clearance of 15 feet.
- ◆ Make sure exterior walls are made of fire-resistant material, such as brick, stone, aluminum or treated wood. Your local Forestry Department can recommend materials.

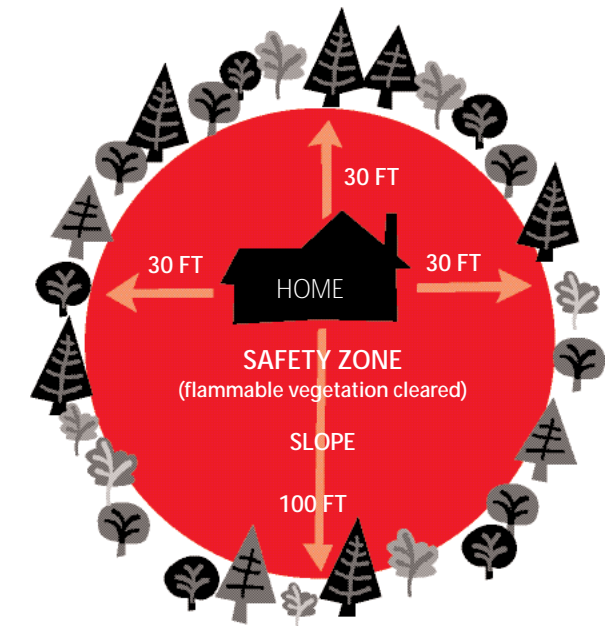

Respond

Fight or flight? In remote areas it may be up to you to put out a small fire before it spreads. Read through these steps to make sure you are ready to respond:

- ◆ Know how to contact your local fire fighting agency.
- ◆ Decide where you would go and what you would take if you have to evacuate (see page 3).
- ◆ Plan at least two escape routes by car and another by foot.
- ◆ Have a ladder available that is long enough to reach your roof.
- ◆ Have fire tools handy: long-handled round-point shovel, rake, axe, gas chainsaw and a 2 1/2 gallon water bucket.

TERRORISM



Be Aware

There are many things you can do to prepare for the unexpected and reduce the stress that you may feel when there is a change in the Department of Homeland Security Alert System.

Prepare

- ◆ Build a disaster supplies kit
- ◆ Establish family reunion sites
- ◆ Create an emergency communications plan
- ◆ Understand evacuation and sheltering-in-place procedures

Respond

- ◆ Follow the advice of local emergency officials. Listen to your radio or television for news and instructions.
- ◆ If the disaster occurs near you, check for injuries. Give first aid and get help for seriously injured people.
- ◆ If the disaster occurs near your home while you are there, check for damage using a flashlight. Do not light matches or candles or turn on electrical switches. Check for fires, fire hazards and other household hazards. Sniff for gas leaks, starting at the water heater. If you smell gas or suspect a leak, turn off the main gas valve, open windows, and quickly get everyone outside.
- ◆ Call your family contact -- do not use the telephone again unless it is a life-threatening emergency.
- ◆ Limit the amount of news coverage children watch. Raw, unedited footage of terrorism events and reactions can be very upsetting to children. If the news show images over and over again, young children may not realize it is repeated video footage. Adults may also need to give themselves a break from the news. Take turns with other adult household members (see *Your Mental Health* on page 4).

VOLCANOES



Be Aware

Explosive volcanoes blast hot solid and molten rock fragments and gases into the air. As a result, ashflows can occur and ash can fall hundreds of miles downwind.

Prepare

- ◆ Learn about your community warning systems and emergency plans.
- ◆ Be prepared for the hazards that can accompany volcanoes, such as mudflows, flash floods, landslides, rockfalls, earthquakes, ashfall and acid rain.
- ◆ If you live in a known volcanic hazard area, plan a route out and have a backup route.
- ◆ Get disposable breathing masks for each member of the household in case of ashfall.

Respond

Although it may seem safe to stay at home and wait out an eruption, if you are in a hazardous zone, doing so could be very dangerous. Follow authorities' instructions and put your disaster plan into action.

Ashfall

Volcanic ash is not poisonous, but it can irritate your respiratory system. Take precautions to protect your lungs if volcanic ash is present by wearing single-use (disposable) paper dust masks. If you have a respiratory ailment, avoid contact with any amount of ash. Stay indoors until local health officials advise it is safe to go outside.

- ◆ Close all windows, doors and dampers.
- ◆ Put all machinery inside a garage or barn.
- ◆ Bring animals and livestock into closed shelters.
- ◆ Clear roofs of ashfall. Ashfall is very heavy and can cause buildings to collapse. Exercise great caution when working on a roof.
- ◆ Avoid driving in heavy ashfall. Driving will stir up more ash that can clog engines and stall vehicles.
- ◆ Avoid areas downwind and river valleys downstream of the volcano.
- ◆ Stay indoors when possible.

24

Remember to help your neighbors who may require special assistance - infants, elderly people and people with disabilities.

TSUNAMIS

Be Aware

A tsunami is a series of ocean waves usually caused by earthquakes or underwater landslides. Tsunami waves may travel up to 600 miles per hour in open water. As they enter shallow water near land, they get higher and can cause great loss of life and property damage. Experts believe a tsunami could hit the Northwest coast with as little as five minutes warning. In low-lying areas without a tsunami warning system, an earthquake may be the only sign a tsunami is approaching. Contact your local emergency management office to find out if there is a tsunami warning system in your area.



UNDERSTANDING TSUNAMI WARNINGS ON RADIO AND TV

Tsunami Advisory: An earthquake has occurred in the Pacific Basin, which might generate a tsunami. Hourly bulletins will be issued to advise you of the situation.

Tsunami Watch: A tsunami was or may have been generated, but is at least two hours travel time to the area in watch status. Local officials should prepare for possible evacuation if their area is upgraded to a warning.

Tsunami Warning: A tsunami was or may have been generated, which could cause damage; therefore, people in the warned area are strongly advised to evacuate.

Prepare

- ◆ Become familiar with the tsunami warning signs. A strong earthquake may generate a tsunami. A noticeable rapid rise or fall in coastal waters is a sign that a tsunami is approaching, in addition to a loud rumbling sound such as rocks being overturned as the water returns.
- ◆ Plan an evacuation route from your home, school, workplace or any other place you'll be where tsunamis present a risk.
- ◆ If you are visiting an area at risk from tsunamis, become familiar with tsunami evacuation information and how you would be warned.
- ◆ Assemble a disaster supplies kit (see page 5) and keep it handy in your home or vehicle.
- ◆ Train all family members over the age of 10 in first aid.
- ◆ While deadly, tsunamis are also very infrequent. Be aware of the risk, but don't let it compromise your plans.
- ◆ Tsunami evacuation maps are available for many coastal communities. Check with your local emergency management office for a map of your area.
- ◆ If you live in an area that may be impacted by a tsunami, consider discussing flood insurance with your insurance agent. Homeowners insurance may not cover flooding from a tsunami.

Respond

- ◆ If you feel an earthquake while you are on the coast, **DROP, COVER and HOLD ON** if inside, and avoid falling objects if outside (see *Earthquakes*, page 20).
- ◆ When the shaking has stopped, move quickly inland and to higher ground. Go on foot if possible. Take your disaster supplies kit, but don't delay leaving.
- ◆ If a tsunami watch is issued, listen to a NOAA weather radio, Coast Guard emergency frequency station or other reliable sources for updated emergency information and be ready to evacuate.
- ◆ Remain inland and on higher ground until an official "all clear" announcement is made by local officials. Typically there are multiple, large waves and tsunamis may last for hours.



Get to higher ground as far inland as possible. Watching a tsunami from the beach or cliffs could put you in grave danger. Return home only after local officials tell you it is safe.

25

PANDEMIC FLU

Pandemic Flu

Pandemic flu is more serious than a "typical" flu. It is caused by a new flu strain that humans have not been exposed to, so they have no natural resistance or immunity to it. Pandemic flu is different from seasonal flu because it infects large numbers of people of different ages all over the world and causes serious illness and possible death.



THE SYMPTOMS OF PANDEMIC FLU ARE LIKELY TO BE SIMILAR TO THE SEASONAL FLU VIRUS:

- ◆ Fever
- ◆ Cough
- ◆ Runny nose
- ◆ Muscle pain
- ◆ Sore throat

Call your healthcare professional at the first sign of the flu.

YOU CAN MAKE GOOD HYGIENE A HABIT AND TAKE ACTIONS TO PREVENT THE SPREAD OF GERMS, INCLUDING:

- ◆ Washing your hands with soap and water or cleaning them with a hand sanitizer.
- ◆ Covering your mouth and nose with a tissue when you cough or sneeze and cleaning your hands afterwards.
- ◆ Coughing or sneezing into your upper sleeve if you don't have a tissue.
- ◆ Staying home if you are sick. Get plenty of rest and drink a lot of fluids.
- ◆ Avoiding close contact with people who are sick.
- ◆ Keeping your living and work area clean.

During a flu pandemic, public officials may impose community-level restrictions to prevent the flu virus from spreading. You may be asked to stay home for an extended period of time even though you are not sick. Schools, workplaces and places of worship may be closed temporarily and mass transportation such as bus, trains and air travel may be limited.

MAKE PLANS NOW FOR A FLU PANDEMIC. THESE ACTIONS MAY LESSEN THE IMPACT ON YOU AND YOUR FAMILY:

- ◆ Figure out what you will do if members of your household have to stay home from work or school or stay separated from others for a period of time. Talk with family members and loved ones about how they would be cared for if they got sick.
- ◆ Store extra supplies of water and food.
- ◆ Store a supply of non-prescription drugs such as pain relievers, cough and cold medicines, stomach remedies and fluids with electrolytes and vitamins.
- ◆ Store health supplies such as bleach, tissue, a thermometer, disposal gloves, soap and alcohol-based hand cleaners.
- ◆ Ask your doctor and insurance company if you can get an extra supply of your regular prescription drugs.

WHEN PREPARING FOR A PANDEMIC FLU, MAKE SURE THAT YOU PUT SUPPLIES ASIDE FOR A PERIOD OF 14 DAYS OR LONGER.

OREGON SAFETY AND EMERGENCY RESOURCES

Oregon Climate Service:
(541) 737-5705
www.ocs.orst.edu/

Oregon Department of Environmental Quality:
(800) 452-4011
www.deq.state.or.us/lq/cu/emergency/index.htm
Information regarding the protection and enhancement of Oregon's water and air quality, clean up and release of hazardous materials and management of proper disposal of hazardous and solid wastes.

The Oregon Department of Geology and Mineral Industries:
(971) 673-1555
www.oregongeology.com/sub/earthquakes/earthquakehome.htm
Information on earthquakes and other natural disasters in the Pacific Northwest.

Oregon Disaster Center:
www.disastercenter.com/oregon/oregon.htm
Information on disasters in Oregon.

Oregon Emergency Management:
(503) 378-2911
www.oregon.gov/OMD/OEM/index.shtm
Information about the prevention, mitigation and management of emergencies or disasters that present a threat to the lives and property of citizens and visitors to the State of Oregon.

Oregon Office of Public Safety and Security:
Local Area 911
www.oregon.gov/OSP/CTS/index.shtml

Oregon Office of the State Fire Marshal:
(503) 378-3473
www.oregon.gov/OSP/SFM
Information regarding the protection of Oregonians' lives and property from fire and hazardous materials.

Oregon Poison Center:
(800) 222-1222
www.ohsu.edu/poison/

Oregon Safe Kids:
(971) 673-1001
www.oregon.gov/DHS/ph/safekids/index.shtml

Partnership for Disaster Resilience:
showcase@uoregon.edu
www.oregonshowcase.org
Provides a comprehensive framework for government and the private sector to prepare for and minimize the risk and impact of natural hazards.



OTHER USEFUL WEB SITES

American National Red Cross
www.redcross.org/services/disaster
Extensive information on disaster preparedness, response and relief, educator information and much more.

Safe and Well
<http://disastersafe.redcross.org>
Online registration that enables family and friends to search for loved ones following a disaster.

Federal Emergency Management Agency – FEMA
www.fema.gov
A great clearinghouse for information on all types of disasters.

Institute for Business and Home Safety
www.disastersafety.org
Extensive "how-to" information to protect your home and business from natural disasters.

U.S. Department of Homeland Security
www.ready.gov
Up-to-date information on homeland security activities and national threat levels.

Center for Disease Control and Prevention
www.cdc.gov
Information on emergency preparedness and flu pandemic.

National Fire Protection Association
www.nfpa.org or www.sparky.org
Extensive fire prevention and safety information. "Sparky the Fire Dog" site contains several multimedia educational activities for kids.

The Weather Channel
www.weather.com/ready
Preparedness information about many kinds of disasters, but with a focus on severe weather.

U.S. Geological Survey
www.usgs.gov
Easily accessible information about geological hazards for each state.

National Weather Service
www.nws.noaa.gov
Latest forecasts, preparedness information, explanations of the different types of weather warnings and more.

EMERGENCY CONTACTS

In case of police, fire or medical emergency, call 9-1-1. For non-emergency concerns, refer to your phone book. Unnecessary calls to 9-1-1 can prevent others from getting the help they need. Fill in the names and numbers below and make copies for each family member:

Out-of-State Contact Person: _____

School(s): _____

Work Site(s): _____

Doctor(s): _____

Neighbor(s): _____

Day Care: _____

E-mail(s): _____

Other: _____

Insurance Agent(s): _____

Family Meeting Places: _____

Outside your home in case of fire: _____

Outside your neighborhood in case you can't return home: _____

Caretaker for Pets: _____

Veterinarian: _____

Utilities:

Water District (broken water pipes in street): _____

Local Fire Bureau: _____

Other Utility: _____

Other Emergency Contacts: _____

REMEMBER TO:

- Make copies of this list for all family members
- Post on refrigerator
- Store with emergency supplies
- Update all copies when numbers change

Red Cross Chapters Serving Oregon

Oregon Trail Chapter

Clackamas, Clatsop, Columbia, Multnomah, Tillamook, Washington, Yamhill
(503) 284-1234
www.redcross-pdx.org

Southern Oregon Chapter

Jackson, Josephine, Klamath, Lake
(541) 779-3773
www.soredcross.org

Oregon Mountain River Chapter

Crook, Deschutes, Gilliam, Grant, Harney, Hood River, Jefferson, Morrow, Sherman, Umatilla, Wheeler, Wallowa, Wasco, Warm Springs
(541) 382-2142
www.mountainriver.redcross.org

Willamette Chapter

Marion, Polk
(503) 585-5414
www.redcross-salem.org

Oregon Pacific Chapter

Benton, Coos, Curry, Douglas, Lane, Lincoln, Linn
(541) 344-5244
www.oregonpacific.redcross.org

